

• HINGED EXTRUSION S 253.
FOR ARTICULATED FURNITURE
AND WALLS.

• SCHARNIERPROFIL S 253.
FÜR MOBILE MÖBEL
UND WÄNDE.

exhibition systems
interior design systems
presentation systems

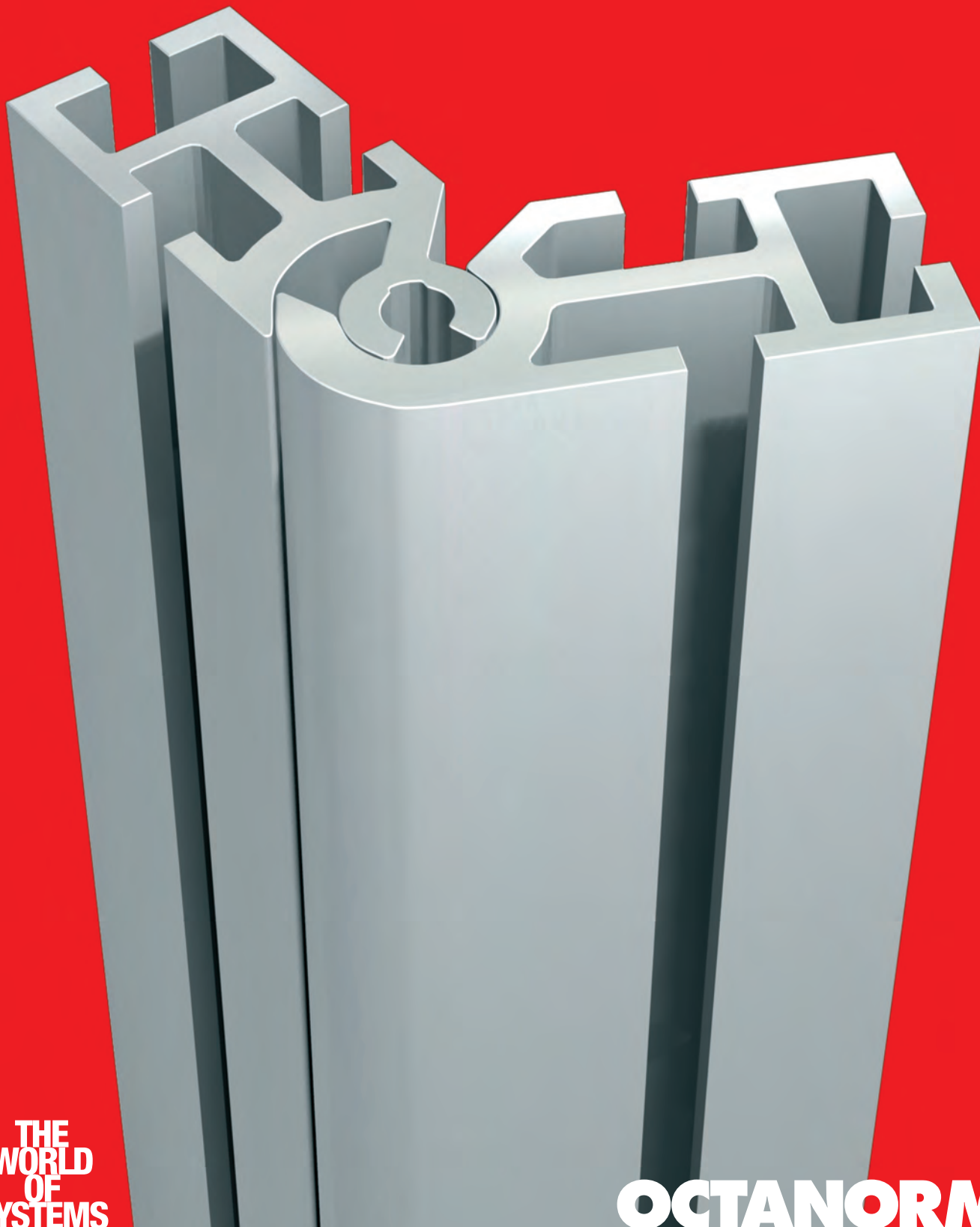

THE
WORLD
OF
SYSTEMS

OCTANORM 



.PARTS AND ACCESSORIES.

.BAUTEILE UND ZUBEHÖR .

**HINGED EXTRUSION
SCHARNIERROFIL**

S 253.01

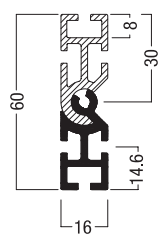

aluminium
two-parts
5000 mm long
16.84 lbs

Aluminium
zweiteilig
5000 mm lang
7,64 kg

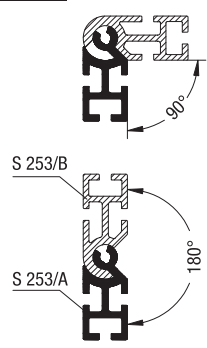

**END CAP SET
ENDKAPPEN-SET**

S 258.35

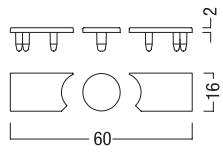

plastic
for extrusion S 253
0.009 lbs

Kunststoff
zum Profil S 253
0,004 kg

**ADJUSTABLE FOOT
VERSTELLFUSS**

S 272.37

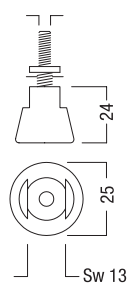

steel
two parts
thread M5 (15 mm long)
height adjustable from 26.5 - 36 mm
0.13 lbs

Stahl
zweiteilig
mit Gewinde M5 (15 mm lang)
höhenverstellbar von 26,5 - 36 mm
0,06 kg

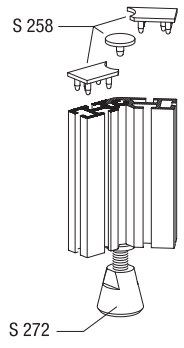

AW 7935_06_2008

.COUNTER.
.THEKE.

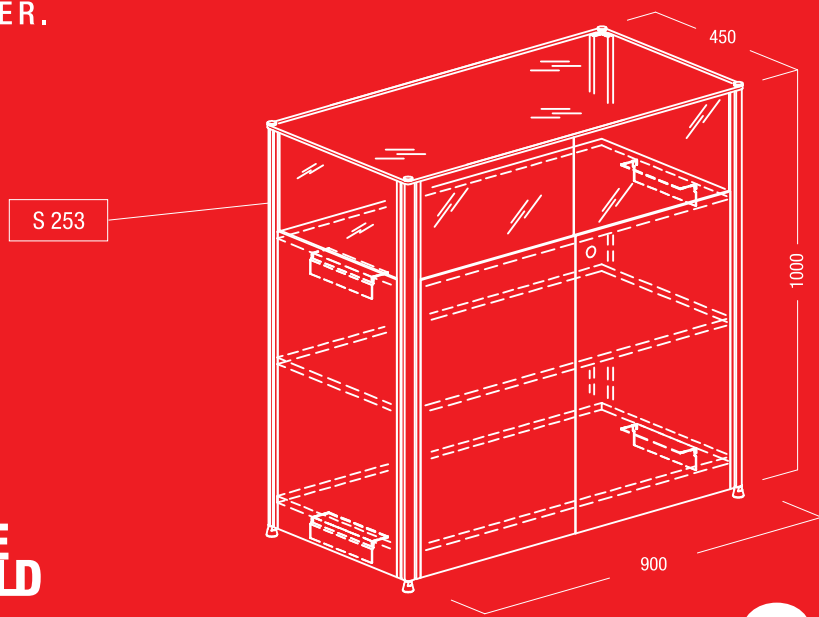

**THE
WORLD
OF
SYSTEMS**

www.octanorm.com

OCTANORM